

NEW!

Acoustically insulated fans

Caissons de ventilation insonorisés

Isolierte Rohrventilatoren

Канальные акустические вентиляторы

 Acoustically insulated duct fans are made of galvanized steel. The fan casing has thermal and acoustic 50 mm insulation. These products can not be operated in explosive environment. Fans can supply/extract clean air. Fans are mounted into the round air duct systems. Centrifugal fans, motors with free-maintenance ball bearings, are used for the AKU fans. The motors have automatic thermal protection. Fans with TK terminals have integrated thermocontact protection of the motor.

Fans have easily opening cover which ensures easy service.

Maximum motor current is marked nearby the rated power supply voltage. If the control voltage is reduced, motor current can exceed the rated current. Considering this, we recommend respective speed controllers for every fan.

Acoustically insulated fans can be mounted only indoors.

 Les caissons de ventilation insonorisés AKU sont réalisés à partir de tôle galvanisée.

L'enveloppe possède une isolation thermique et acoustique de 50 mm. Ces produits sont destinés à la ventilation d'air hygiénique et ne sont pas appropriés à un fonctionnement en environnement à risque d'explosion. Ils sont pourvus de piquages avec joint pour un raccordement direct sur conduits d'air circulaires.

Les ventilateurs centrifuges utilisés dans les caissons AKU sont équipés moto-ventilateurs à rotor extérieur, ne nécessitant pas d'entretien. Les moteurs possèdent une protection thermique à réarmement automatique.

Les ventilateurs avec bornes TK-TK intègrent une protection du moteur par thermocontact.

L'entretien et la maintenance des ventilateurs sont facilités grâce au panneau d'ouverture sur charnières.

C'est pourquoi il est facile d'entretenir les ventilateurs. Le courant maximal et la puissance des moteurs sont indiqués près de la tension d'alimentation nominale. La variation de vitesse peut se faire par variation de tension. A cet égard, nous recommandons pour chaque ventilateur les régulateurs de vitesses adéquates.

Les caissons AKU sont exclusivement prévus pour un montage intérieur.

Accessories

AP
p. 238AGO
p. 227RSK
p. 218AKS
p. 206FD
p. 197FDI
p. 198

 Schallgedämmte Kanalventilatoren AKU bestehen aus verzinktem Stahlblech. Das Gehäuse der Ventilatoren ist mit einer 50 mm starken Isolation versehen, welche akustisch und wärmetechnisch isoliert. Diese Ventilatoren dürfen nicht in explosionsgefährdeter Umgebung installiert werden. Sie dienen der Be- und Entlüftung. Sie werden an runde Luftkanäle angeschlossen. Die AKU Geräte sind mit radialen Ventilatoren ausgerüstet, deren Lager keiner Aufsicht bedürfen. Die Elektromotoren sind mit PTC-Fühlern oder Thermokontakten zu deren Schutz versehen. Ventilatoren mit TK-Klemmen besitzen einen Thermokontakt.

Dank ihrer guten Zugänglichkeit ist die Wartung der Ventilatoren einfach.

Der Motoren-Nennstrom ist angegeben und darf nicht überschritten werden. Nur bei verringerter Steuerspannung darf der Nennstrom auch etwas darüber liegen. Wir empfehlen für jeden Ventilator den Einsatz eines Drehzahlreglers.

AKU Ventilatoren sind nur innerhalb der Gebäude einzusetzen (nicht im Freien).

 Канальные акустические вентиляторы изготавливаются из оцинкованной жести. Корпус вентиляторов имеет 50 мм слой термической и акустической изоляции. Эти изделия не могут работать во взрывоопасной среде. Эксплуатируются в целях подачи и вытяжки чистого воздуха. Монтируются в системы круглых воздуховодов. В вентиляторах AKU используется центробежные вентиляторы, подшипники двигателей которые не требуют ухода. Двигатели оснащены автоматической теплозащитой. Вентиляторы с клеммами ТК имеют встроенную термоконтактную защиту двигателя.

Обзорная крышка вентилятора открывается легко, что обеспечивает удобное обслуживание.

Максимальный ток двигателя указан рядом с номинальным напряжением питания. При снижении напряжения ток двигателя может превысить указанное значение. Поэтому для каждого вентилятора рекомендуем соответствующие регуляторы скоростей.

Акустические вентиляторы монтируются только в закрытых помещениях.

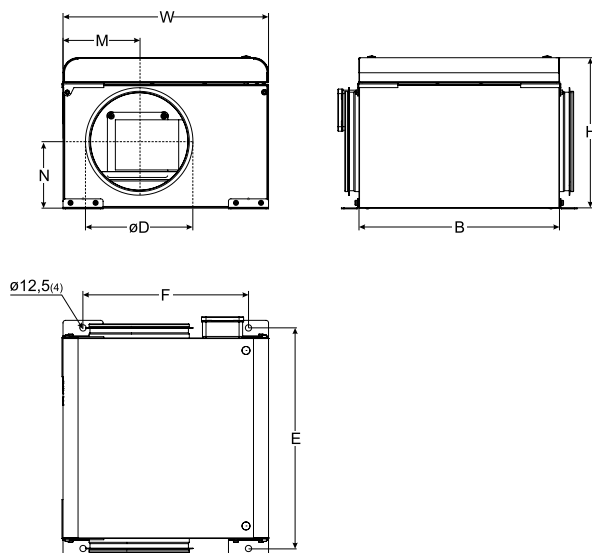

Type	Dimensions [mm]							
	B	W	H	M	N	øD	E	F
AKU 125 M	400	410	300	277	171,5	125	440	330
AKU 125 D	400	410	300	277	171,5	125	440	330
AKU 160 M	400	410	300	148,5	142,5	160	440	330
AKU 160 D	400	410	300	148,5	142,5	160	440	330
AKU 200 M	444	444	420	222	251,5	200	484	364
AKU 200 D	400	410	300	152	134,5	200	440	330
AKU 200 S	600	560	420	390	244,5	200	640	480
AKU 250 M	444	444	420	222	221,5	250	484	364
AKU 250 D	694	694	500	476	304	250	734	614
AKU 250 S	694	694	500	466	304	250	734	614
AKU 315 M	694	694	500	458	267,5	315	734	614
AKU 315 D	768	768	570	516	319,5	315	808	688
AKU 400 D	768	768	570	516	304,5	400	808	688
AKU 400 S	705	768	685	384	309	400	745	688

Accessories



EKA
p. 160

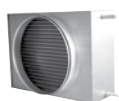

AVS
p. 168



GAO
p. 228



TGRV
p. 185



MTY
p. 188

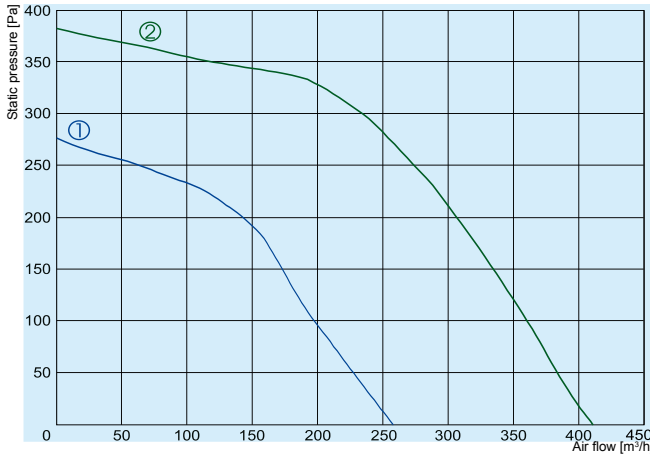

① AKU 125 M
② AKU 125 D

		AKU 125 M	AKU 125 D
Voltage/Frequency	[V/Hz]	~1, 230	~1, 230
Power consumption	[kW]	0,075	0,120
Current	[A]	0,33	0,53
Speed	[min ⁻¹]	2335	2480
Max. airflow	[m ³ /h]	258	411
Max. air temperature	[°C]	55	65
Total sound pressure level at 1 m	[dBA]	35	38
Speed controller		TGRV1,5 / MTY0	TGRV1,5 / MTY1
Weight	[kg]	12,0	13,0
Wiring diagram		No. 2	No. 1
Protection class:	motor	IP-44	IP-44
	terminal box	IP-55	IP-55

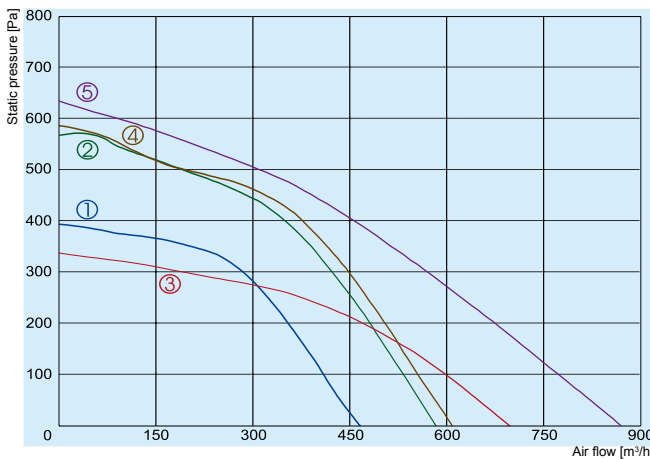

① AKU 160 M
② AKU 160 D
③ AKU 200 M
④ AKU 200 D
⑤ AKU 200 S

		AKU 160 M	AKU 160 D	AKU 200 M	AKU 200 D	AKU 200 S
Voltage/Frequency	[V/Hz]	~1, 230	~1, 230	~1, 230	~1, 230	~1, 230
Power consumption	[kW]	0,135	0,215	0,167	0,239	0,145
Current	[A]	0,59	0,93	0,72	1,04	0,64
Speed	[min ⁻¹]	2480	2130	1550	2130	2510
Max. airflow	[m ³ /h]	465	583	697	611	870
Max. air temperature	[°C]	65	65	65	65	65
Total sound pressure level at 1 m	[dBA]	38	41	40	46	50
Speed controller		TGRV1,5 / MTY1	TGRV1,5 / MTY2	TGRV1,5 / MTY1	TGRV1,5 / MTY2	TGRV1,5 / MTY1
Weight	[kg]	13,0	14,0	17,0	13,0	26,0
Wiring diagram		No. 1	No. 1	No. 1	No. 1	No. 1
Protection class:	motor	IP-44	IP-44	IP-44	IP-44	IP-44
	terminal box	IP-55	IP-55	IP-55	IP-55	IP-55

The fan characteristic curves were determined in accordance with DIN 24163 resp. ISO 5801. The sound power levels were determined in accordance with DIN 45635 resp. ISO 3744 at a distance of 1 m from the fan

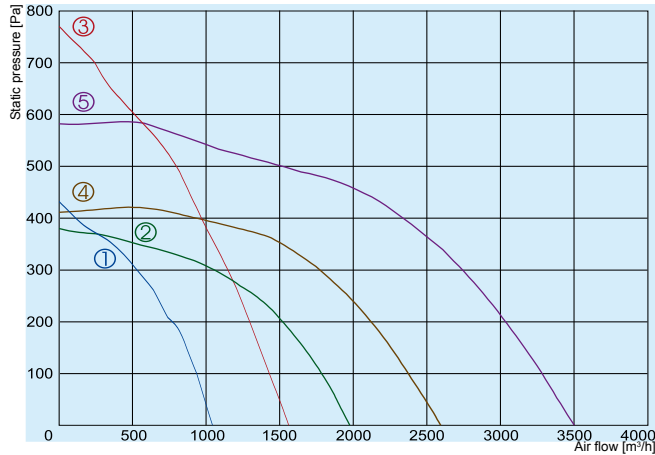

- ① AKU 250 M
- ② AKU 250 D
- ③ AKU 250 S
- ④ AKU 315 M
- ⑤ AKU 315 D

		AKU 250 M	AKU 250 D	AKU 250 S	AKU 315 M	AKU 315 D
Voltage/Frequency	[V/Hz]	~1, 230	~1, 230	~1, 230	~1, 230	~1, 230
Power consumption	[kW]	0,265	0,545	0,310	0,950	1,505
Current	[A]	1,15	2,56	1,35	4,79	6,61
Speed	[min ⁻¹]	2082	1190	2665	1210	1290
Max. airflow	[m ³ /h]	1045	1976	1563	2596	3499
Max. air temperature	[°C]	40	40	60	40	40
Total sound pressure level at 1 m	[dBA]	51	49	51	53	60
Speed controller		TGRV2 / MTY2	TGRV3 / MTY4	TGRV2 / MTY2	TGRV5	TGRV11
Weight	[kg]	18,0	39,0	37,0	47,0	63,0
Wiring diagram		No. 2	No. 3	No. 2	No. 3	No. 3
Protection class:	motor	IP-44	IP-54	IP-44	IP-54	IP-54
	terminal box	IP-55	IP-55	IP-55	IP-55	IP-55

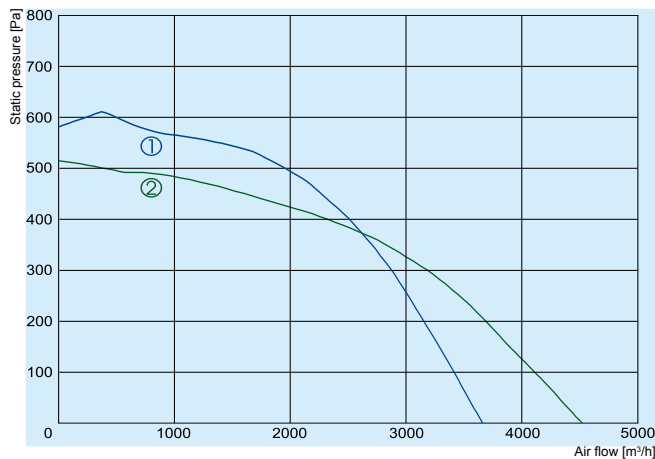

- ① AKU 400 D
- ② AKU 400 S

		AKU 400 D	AKU 400 S
Voltage/Frequency	[V/Hz]	~1, 230	~1, 230
Power consumption	[kW]	1,720	1,474
Current	[A]	7,63	6,49
Speed	[min ⁻¹]	1290	1500
Max. airflow	[m ³ /h]	3664	4521
Max. air temperature	[°C]	40	40
Total sound pressure level at 1 m	[dBA]	60	69
Speed controller		TGRV11	TGRV7
Weight	[kg]	63,0	70,0
Wiring diagram		No. 3	No. 4
Protection class:	motor	IP-54	IP-54
	terminal box	IP-55	IP-55

The fan characteristic curves were determined in accordance with DIN 24163 resp. ISO 5801. The sound power levels were determined in accordance with DIN 45635 resp. ISO 3744 at a distance of 1 m from the fan

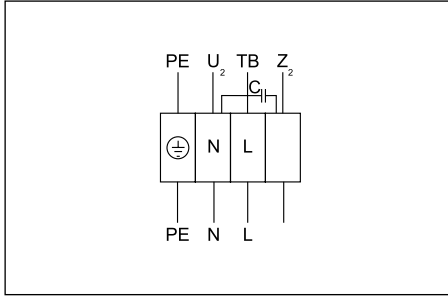

Wiring diagram No. 1 (1~230V)

PE - yellow-green
 U₂ - blue
 Z₂ - black
 TB - brown

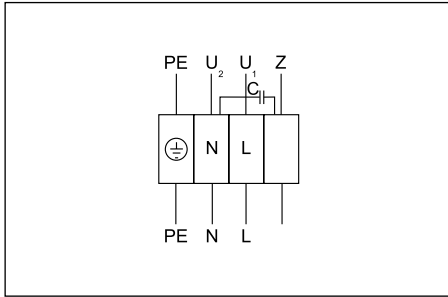

Wiring diagram No. 2 (1~230V)

PE - yellow-green
 U₂ - black
 U₁ - blue
 Z - brown

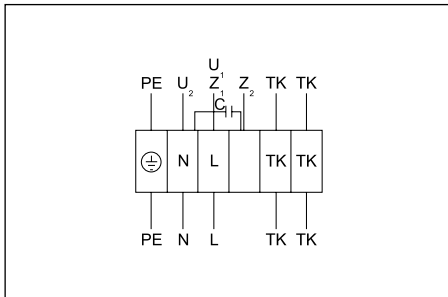

Wiring diagram No. 3 (1~230V)

PE - yellow-green
 U₁ - brown
 U₂ - blue
 Z₁ - black
 Z₂ - orange
 TK - white

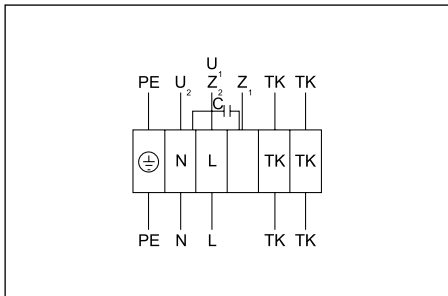

Wiring diagram No. 4 (1~230V)

PE - yellow-green
 U₁ - brown
 U₂ - blue
 Z₁ - black
 Z₂ - orange
 TK - white