



Air handling units

Centrales de traitement d'air simple flux

Lüftungsgeräte

Приточные агрегаты



- Low noise level.
- Adjustable voltage fan control.
- Electrical or water heater.
- Easily removable inspection cover.
- Filter box with pocket filter EU5 class.
- Possibility to install in ceiling.

Air supply units for ventilation systems. Units' casing is made of zinc-coated steel and have insulation of 50 mm. Consist of voltage controllable centrifugal fan, heater (electrical or water), pocket filtre. Not designed for functioning in explosive – inclined areas. Units are designed for clean air supply into premises. Have additional mounting brackets and can be mounted on ceiling.



- Niedriges Geräuschniveau.
- Ventilator mit Geschwindigkeitsregelung (Spannungsänderung).
- Elektrische oder Wasser-Erwärmungseinrichtung.
- Leicht abnehmbarer Deckel für Wartung.
- Filterkasten mit dem Filter der EU5-Klasse.

Das Zuluft-Aggregat ist für Luftlieferung in Räumlichkeiten bestimmt. Es besteht aus einem Zentrifugalventilator, dessen Geschwindigkeit mithilfe eines Reglers gesteuert werden kann, einer Lufterwärmungseinrichtung und einem Taschenfilter. Alle diese Elemente sind im isolierten Gehäuse montiert. Isolationsdicke 50 mm. Das Gehäuse ist aus verzinktem Blech mit leicht abnehmbarem Deckel hergestellt. Der Deckel wird mit vier leicht aufknöpfbaren Scharnieren befestigt.



- Faible niveau de bruit.
- Ventilateur à vitesse réglée (changement d'intensité).
- Batterie électrique ou à eau chaude.
- Ouverture facile du panneau.
- Cassette de filtres avec filtre de classe EU5.

Les unités sont destinées à l'apport d'air dans les locaux. Elles se composent d'un ventilateur centrifuge dont la vitesse peut être pilotée par un régulateur, d'une batterie terminale et d'un filtre à poche. Tous ces éléments sont montés dans une enveloppe isolée. Épaisseur de l'isolation 50 mm. L'enveloppe est réalisée en tôle galvanisée avec un panneau pouvant être facilement ouvert.

Le panneau est consolidé par quatre charnières facilement détachables.



- Низкий уровень шума.
- Вентилятор с регулированием скорости (изменение напряжения).
- Электрический или водяной нагреватель.
- Легко снимаемая крышка для проверки.
- Кассета фильтров с фильтром класса EU5.

Агрегат подачи воздуха предназначен для подачи воздуха в помещения. Он состоит из эксцентрического вентилятора, скорость которого изменяется регулятором, а также нагревателя воздуха и карманного фильтра. Все эти элементы установлены в изолированном корпусе. Толщина изоляции 50 мм. Корпус изготовлен из оцинкованной жести с легко снимаемой крышкой. Крышка крепится легко отстегивающимися шарнирами.

## Accessories

AP  
p. 238RSK  
p. 218SKG  
p. 210SSK  
p. 216SSP  
p. 205AKS  
p. 206SP  
p. 208

VEKA 400 - 2000

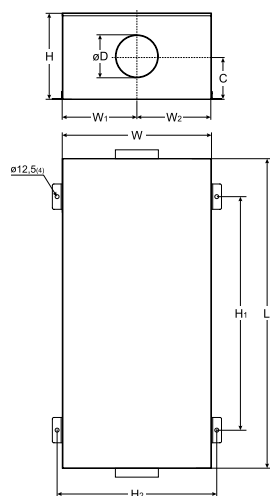

VEKA 3000 - 4000

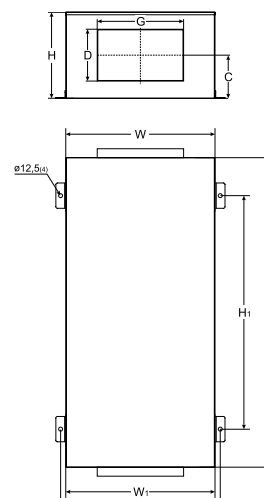

Type	Dimensions [mm]								
	W	W1	W2	C	L	H	ØD	H	H <sub>1</sub>
VEKA 400	434	215	215	125	900	250	125	640	470
VEKA 700/2,4 - 9,0	464	230	230	216	1000	400	160	700	500
VEKA 700/12,0	464	230	230	216	1130	400	160	780	500
VEKA 850/2,0 - 3,0	464	230	230	216	1000	400	200	800	500
VEKA 850/5,0 - 9,0	464	230	230	216	1100	400	200	800	500
VEKA 850/12,0	464	230	230	216	1230	400	200	880	500
VEKA 1000/2,4	614	210	400	198	1150	400	250	880	652
VEKA 1000/5,0	614	210	400	198	1300	400	250	900	652
VEKA 1000/9,0 - 12,0	614	210	400	198	1400	400	250	900	652
VEKA W-1000/13,6	614	210	400	198	1400	400	250	950	652
VEKA 2000	704	285	415	256	1500	500	315	100	842

Type	Dimensions [mm]								
	W	W1	C	L	H	D	G	H	H <sub>1</sub>
VEKA 3000	824	820	239	1500	500	300	500	1000	862
VEKA 4000	924	920	300	1700	600	400	600	1400	962

Accessories



TJK  
p. 195



PS  
p. 194



TGRV  
p. 185



TGRT  
p. 186



MTY  
p. 188



EKR 15.1  
EKR 15.1P  
p. 182-183



EKR 6.1  
p. 184

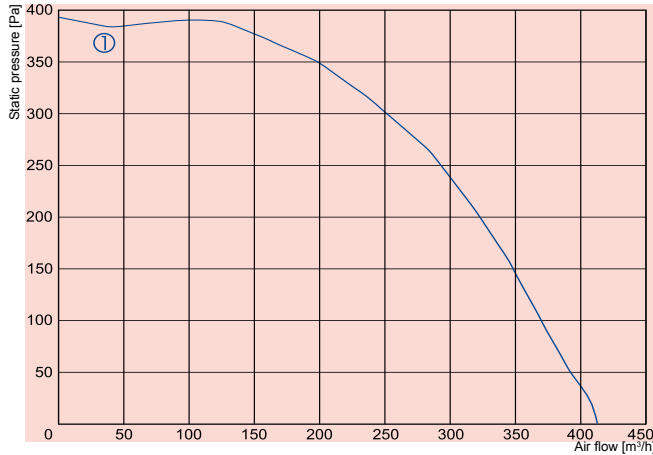

- ① VEKA 400/1,2-L1
- ① VEKA 400/2,0-L1
- ① VEKA 400/5,0-L1

		400/1,2-L1	400/2,0-L1	400/5,0-L1
Heater	-phase/voltage [50Hz/VAC]	~1, 230	~1, 230	~2, 400
	-power consumption [kW]	1,2	2,0	5,0
	-min. air speed [m/s]	1,5	1,5	1,5
Fan	-phase/voltage [50Hz/VAC]	~1, 230	~1, 230	~1, 230
	-current [A]	0,72	0,72	0,72
	-speed [min <sup>-1</sup> ]	2300	2300	2300
	-power consumption [kW]	0,16	0,16	0,16
	-max. airflow [m³/h]	414	414	414
	-motor protection class	IP-44	IP-44	IP-44
	Terminal box protection class	IP-54	IP-54	IP-54
	Filter class	EU5	EU5	EU5
	Total sound pressure level at 1 m [dBA]	41	41	41
	Wiring diagram	No. 1	No. 1	No. 2

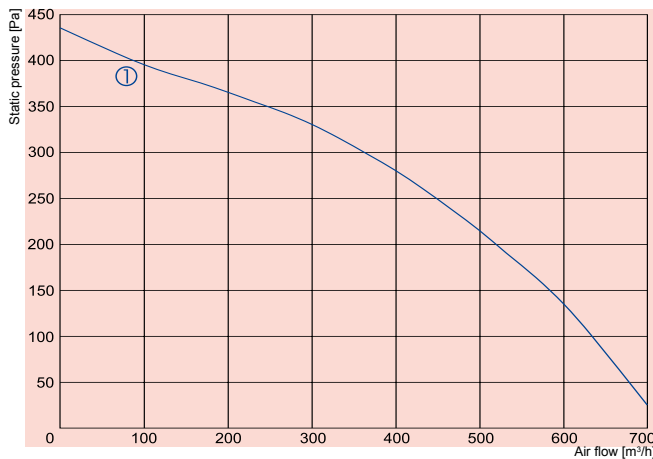

- ① VEKA 700/2,4-L1
- ① VEKA 700/5,0-L1
- ① VEKA 700/9,0-L1
- ① VEKA 700/12,0-L1

		700/2,4-L1	700/5,0-L1	700/9,0-L1	700/12,0-L1
Heater	-phase/voltage [50Hz/VAC]	~1, 230	~2, 400	~3, 400	~3, 400
	-power consumption [kW]	2,4	5,0	9,0	12,0
	-min. air speed [m/s]	1,5	1,5	1,5	1,5
Fan	-phase/voltage [50Hz/VAC]	~1, 230	~1, 230	~1, 230	~1, 230
	-current [A]	1,0	1,0	1,0	1,0
	-speed [min <sup>-1</sup> ]	2200	2200	2200	2200
	-power consumption [kW]	0,23	0,23	0,23	0,23
	-max. airflow [m³/h]	700	700	700	700
	-motor protection class	IP-44	IP-44	IP-44	IP-44
	Terminal box protection class	IP-54	IP-54	IP-54	IP-54
	Filter class	EU5	EU5	EU5	EU5
	Total sound pressure level at 1 m [dBA]	45	45	45	45
	Wiring diagram	No. 1	No. 2	No. 3	No. 3

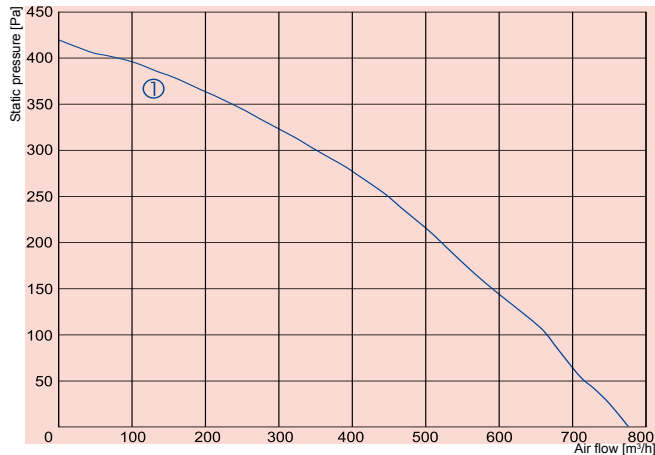

- ① VEKA 850/2,0-L1
- ① VEKA 850/3,0-L1
- ① VEKA 850/5,0-L1
- ① VEKA 850/6,0-L1
- ① VEKA 850/9,0-L1
- ① VEKA 850/12,0-L1

		850/2,0-L1	850/3,0-L1	850/5,0-L1	850/6,0-L1	850/9,0-L1	850/12,0-L1
Heater	-phase/voltage [50Hz/VAC]	~1, 230	~1, 230	~2, 400	~2, 400	~3, 400	~3, 400
	-power consumption [kW]	2	3	5	6	9	12
	-min. air speed [m/s]	1,5	1,5	1,5	1,5	1,5	1,5
Fan	-phase/voltage [50Hz/VAC]	~1, 230	~1, 230	~1, 230	~1, 230	~1, 230	~1, 230
	-current [A]	1,12	1,12	1,12	1,12	1,12	1,12
	-speed [min <sup>-1</sup> ]	2000	2000	2000	2000	2000	2000
	-power consumption [kW]	0,25	0,25	0,25	0,25	0,25	0,25
	-max. airflow [m³/h]	775	775	775	775	775	775
	-motor protection class	IP-44	IP-44	IP-44	IP-44	IP-44	IP-44
Terminal box protection class		IP-54	IP-54	IP-54	IP-54	IP-54	IP-54
Filter class		EU5	EU5	EU5	EU5	EU5	EU5
Total sound pressure level at 1 m	[dBA]	46	46	46	46	46	46
Wiring diagram		No. 1	No. 1	No. 2	No. 2	No. 3	No. 3

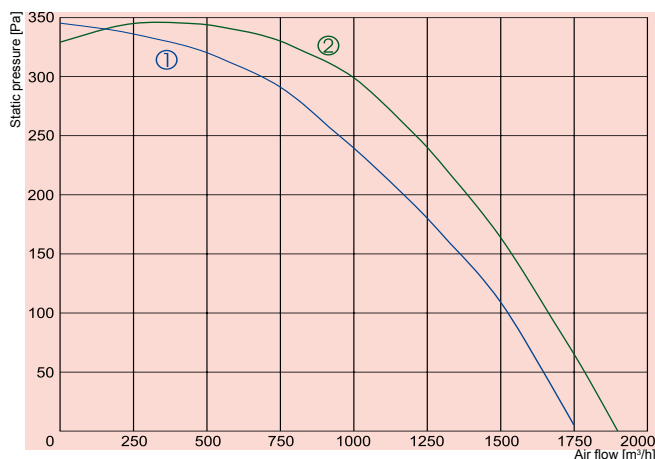

- ① VEKA1000/2,4-L1
- ② VEKA1000/2,4-L3
- ① VEKA1000/5,0-L1
- ② VEKA1000/5,0-L3

		1000/2,4-L1	1000/2,4-L3	1000/5,0-L1	1000/5,0-L3
Heater	-phase/voltage [50Hz/VAC]	~1, 230	~1, 230	~2, 400	~2, 400
	-power consumption [kW]	2,4	2,4	5	5
	-min. air speed [m/s]	1,5	1,5	1,5	1,5
Fan	-phase/voltage [50Hz/VAC]	~1, 230	~3, 400	~1, 230	~3, 400
	-current [A]	3,0	1,9	3,0	1,9
	-speed [min <sup>-1</sup> ]	1190	1380	1190	1380
	-power consumption [kW]	0,69	0,93	0,69	0,93
	-max. airflow [m³/h]	1750	1900	1750	1900
	-motor protection class		IP-54	IP-54	IP-54
Terminal box protection class		IP-54	IP-54	IP-54	IP-54
Filter class		EU5	EU5	EU5	EU5
Total sound pressure level at 1 m	[dBA]	52	52	52	52
Wiring diagram		No. 4	No. 5	No. 6	No. 7

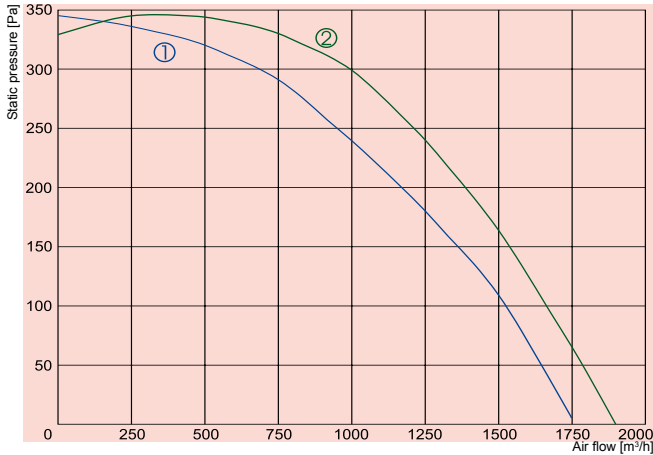

- ① — VEKA1000/9,0-L1
- ② — VEKA1000/9,0-L3
- ① — VEKA1000/12,0-L1
- ② — VEKA1000/12,0-L3

		1000/9,0-L1	1000/9,0-L3	1000/12,0-L1	1000/12,0-L3
Heater	-phase/voltage [50Hz/VAC]	~3, 400	~3, 400	~3, 400	~3, 400
	-power consumption [kW]	9	9	12	12
	-min. air speed [m/s]	1,5	1,5	1,5	1,5
Fan	-phase/voltage [50Hz/VAC]	~1, 230	~3, 400	~1, 230	~3, 400
	-current [A]	3,0	1,9	3,0	1,9
	-speed [min <sup>-1</sup> ]	1190	1380	1190	1380
	-power consumption [kW]	0,69	0,93	0,69	0,93
	-max. airflow [m³/h]	1750	1900	1750	1900
	-motor protection class	IP-54	IP-54	IP-54	IP-54
	Terminal box protection class	IP-54	IP-54	IP-54	IP-54
	Filter class	EU5	EU5	EU5	EU5
	Total sound pressure level at 1 m [dBA]	52	52	52	52
	Wiring diagram	No. 8	No. 9	No. 12	No. 13

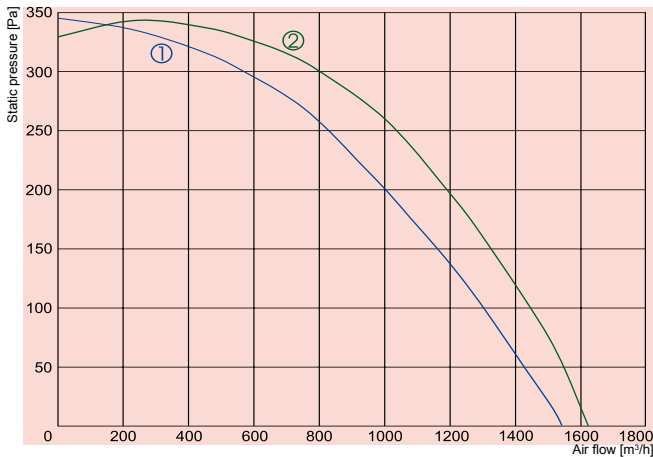

- ① — VEKA W-1000/13,6-L1
- ② — VEKA W-1000/13,6-L3

		W-1000/13,6-L1	W-1000/13,6-L3
Water heater	-power [kW]	13,6	13,6
	-water temp. T <sub>in</sub> /T <sub>out</sub> [°C]	+80/+60	+80/+60
	-water flow rate [l/s]	0,16	0,16
	-water pressure drop [kPa]	15,8	15,8
	-kvs value [m³/h]	1,5	1,5
Fan	-phase/voltage [50Hz/VAC]	~1, 230	~3, 400
	-current [A]	3,0	1,9
	-speed [min <sup>-1</sup> ]	1190	1380
	-power consumption [kW]	0,69	0,93
	-max. airflow [m³/h]	1540	1620
	-motor protection class	IP-54	IP-54
	Terminal box protection class	IP-54	IP-54
	Filter class	EU5	EU5
	Total sound pressure level at 1 m [dBA]	52	52
	Wiring diagram	No. 14	No. 15

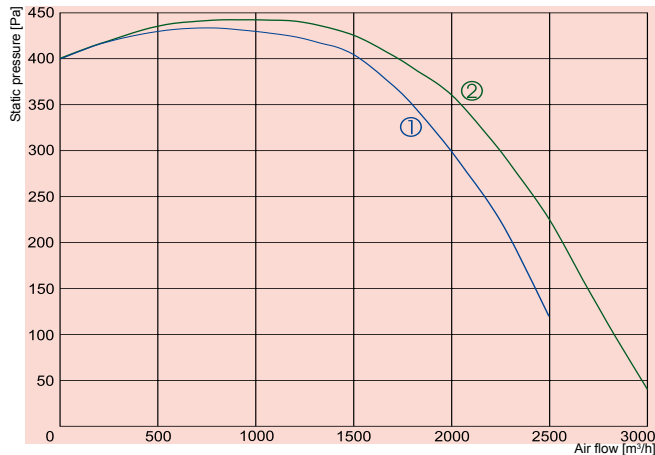

- ① — VEKA 2000/6,0-L1
- ② — VEKA 2000/6,0-L3
- ① — VEKA 2000/15,0-L1
- ② — VEKA 2000/15,0-L3
- ① — VEKA 2000/21,0-L1
- ② — VEKA 2000/21,0-L3

		2000/6,0-L1	2000/6,0-L3	2000/15,0-L1	2000/15,0-L3	2000/21,0-L1	2000/21,0-L3
Heater	-phase/voltage [50Hz/VAC]	~2, 400	~2, 400	~3, 400	~3, 400	~3, 400	~3, 400
	-power consumption [kW]	6	6	15	15	21 (9+12)	21 (9+12)
	-min. air speed [m/s]	1,5	1,5	1,5	1,5	1,5	1,5
Fan	-phase/voltage [50Hz/VAC]	~1, 230	~3, 400	~1, 230	~3, 400	~1, 230	~3, 400
	-current [A]	5,1	2,6	5,1	2,6	5,1	2,6
	-speed [min <sup>-1</sup> ]	1210	1310	1210	1310	1210	1310
	-power consumption [kW]	1,15	1,50	1,15	1,50	1,15	1,50
	-max. airflow [m³/h]	2500	3000	2500	3000	2500	3000
-motor protection class		IP-54	IP-54	IP-54	IP-54	IP-54	IP-54
Terminal box protection class		IP-54	IP-54	IP-54	IP-54	IP-54	IP-54
Filter class		EU5	EU5	EU5	EU5	EU5	EU5
Total sound pressure level at 1 m [dBA]		54	54	54	54	54	54
Wiring diagram		No. 10	No. 11	No. 12	No. 13	No. 12	No. 13

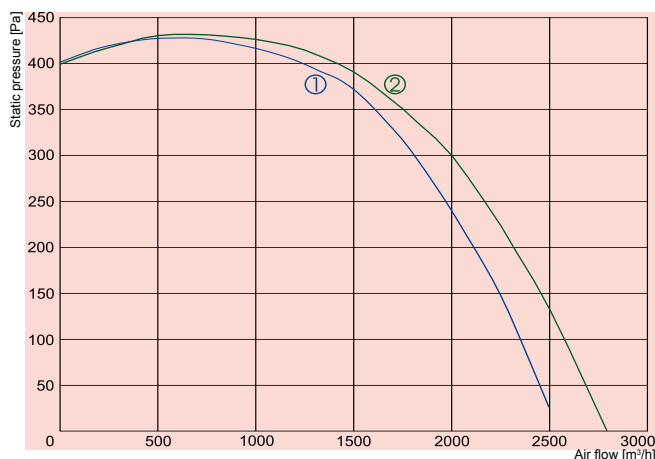

- ① — VEKA W-2000/27,2-L1
- ② — VEKA W-2000/27,2-L3

		W-2000/27,2-L1	W-2000/27,2-L3
Water heater	-power [kW]	27,2	27,2
	-water temp. T <sub>in</sub> /T <sub>out</sub> [°C]	+80/+60	+80/+60
	-water flow rate [l/s]	0,32	0,32
	-water pressure drop [kPa]	9,6	9,6
	-kvs value [m³/h]	3,7	3,7
Fan	-phase/voltage [50Hz/VAC]	~1, 230	~3, 400
	-current [A]	5,1	2,6
	-speed [min <sup>-1</sup> ]	1210	1310
	-power consumption [kW]	1,15	1,50
	-max. airflow [m³/h]	2500	2790
-motor protection class		IP-54	IP-54
Terminal box protection class		IP-54	IP-54
Filter class		EU5	EU5
Total sound pressure level at 1 m [dBA]		54	54
Wiring diagram		No. 14	No. 15

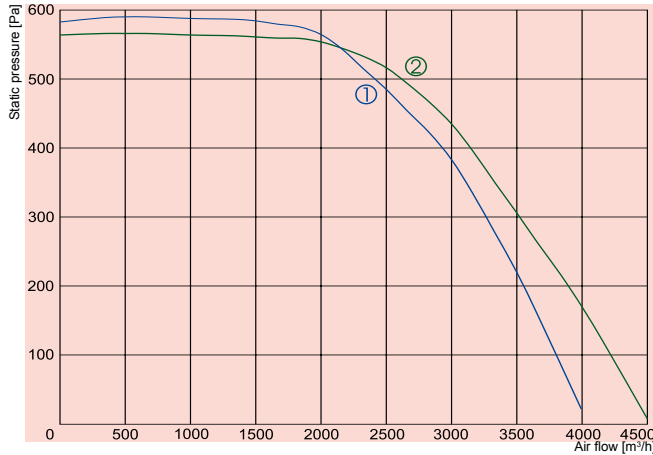

- ① — VEKA 3000/15,0-L1
- ② — VEKA 3000/15,0-L3
- ① — VEKA 3000/21,0-L1
- ② — VEKA 3000/21,0-L3

		3000/15,0-L1	3000/15,0-L3	3000/21,0-L1	3000/21,0-L3
Heater	-phase/voltage [50Hz/VAC]	~3, 400	~3, 400	~3, 400	~3, 400
	-power consumption [kW]	15	15	21 (9+12)	21 (9+12)
	-min. air speed [m/s]	1,5	1,5	1,5	1,5
Fan	-phase/voltage [50Hz/VAC]	~1, 230	~3, 400	~1, 230	~3, 400
	-current [A]	11,0	4,1	11,0	4,1
	-speed [min <sup>-1</sup> ]	1340	1300	1340	1300
	-power consumption [kW]	2,5	2,5	2,5	2,5
	-max. airflow [m³/h]	4000	4500	4000	4500
-motor protection class		IP 54	IP 54	IP 54	IP 54
Terminal box protection class		IP 54	IP 54	IP 54	IP 54
Filter class		EU5	EU5	EU5	EU5
Total sound pressure level at 1 m [dBA]		56	56	56	56
Wiring diagram		No 12	No. 13	No. 12	No. 13

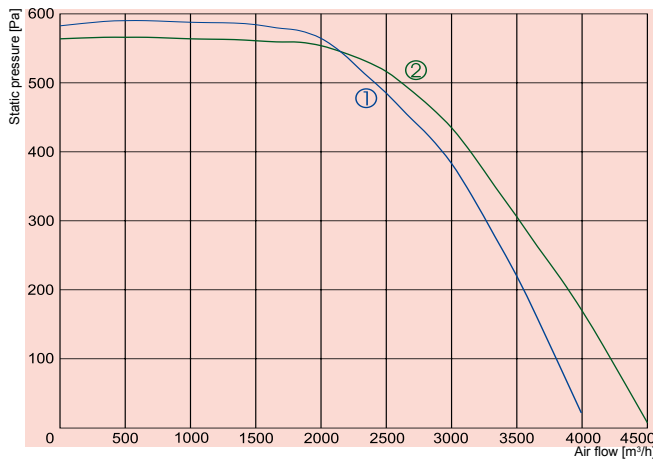

- ① — VEKA 3000/30,0-L1
- ② — VEKA 3000/30,0-L3
- ① — VEKA 3000/39,0-L1
- ② — VEKA 3000/39,0-L3

		3000/30,0-L1	3000/30,0-L3	3000/39,0-L1	3000/39,0-L3
Heater	-phase/voltage [50Hz/VAC]	~3, 400	~3, 400	~3, 400	~3, 400
	-power consumption [kW]	30 (15+15)	30 (15+15)	39 (9+12+18)	39 (9+12+18)
	-min. air speed [m/s]	1,5	1,5	1,5	1,5
Fan	-phase/voltage [50Hz/VAC]	~1, 230	~3, 400	~1, 230	~3, 400
	-current [A]	11,0	4,1	11,0	4,1
	-speed [min <sup>-1</sup> ]	1340	1300	1340	1300
	-power consumption [kW]	2,5	2,5	2,5	2,5
	-max. airflow [m³/h]	4000	4500	4000	4500
-motor protection class		IP 54	IP 54	IP 54	IP 54
Terminal box protection class		IP 54	IP 54	IP 54	IP 54
Filter class		EU5	EU5	EU5	EU5
Total sound pressure level at 1 m [dBA]		56	56	56	56
Wiring diagram		No. 12	No. 13	No. 12	No. 13

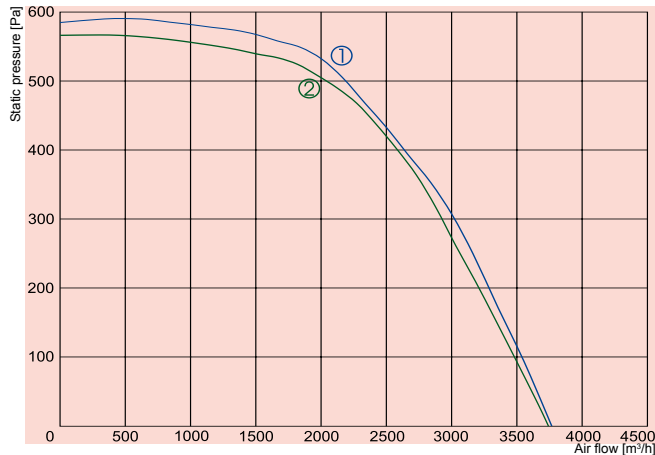

- ① VEKA W-3000/40,8-L1
- ② VEKA W-3000/40,8-L3

		W-3000/40,8-L1	W-3000/40,8-L3
Water heater	-power [kW]	40,8	40,8
	-water temp. $T_{in}/T_{out}$ [°C]	+80/+60	+80/+60
	-water flow rate [l/s]	0,49	0,49
	-water pressure drop [kPa]	5,7	5,7
	-kvs value [m³/h]	7,4	7,4
Fan	-phase/voltage [50Hz/VAC]	~1, 230	~3, 400
	-current [A]	11	4,10
	-speed [min <sup>-1</sup> ]	1340	1300
	-power consumption [kW]	2,5	2,5
	-max. airflow [m³/h]	3770	3740
	-motor protection class	IP 54	IP 54
Terminal box protection class		IP 54	IP 54
Filter class		EU5	EU5
Total sound pressure level at 1 m [dBA]		56	56
Wiring diagram		No. 14	No. 15

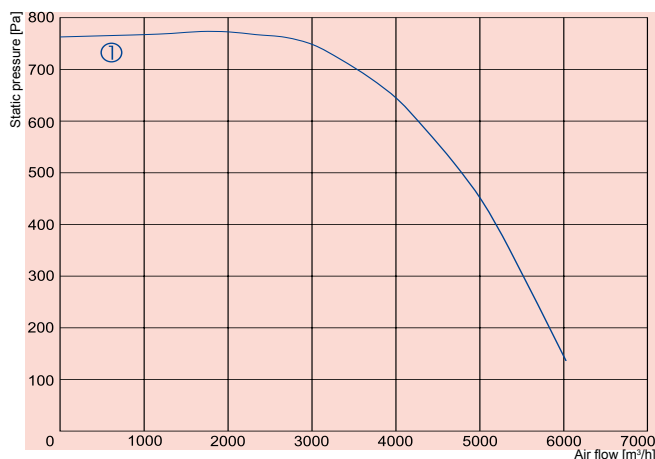

- ① VEKA 4000/21,0-L3
- ① VEKA 4000/27,0-L3
- ① VEKA 4000/39,0-L3
- ① VEKA 4000/54,0-L3

		4000/21,0-L3	4000/27,0-L3	4000/39,0-L3	4000/54,0-L3
Heater	-phase/voltage [50Hz/VAC]	~3, 400	~3, 400	~3, 400	~3, 400
	-power consumption [kW]	21 (9+12)	27 (12+15)	39 (9+12+18)	54 (9+12+15+18)
	-min. air speed [m/s]	1,5	1,5	1,5	1,5
Fan	-phase/voltage [50Hz/VAC]	~3, 400	~3, 400	~3, 400	~3, 400
	-current [A]	6,0	6,0	6,0	6,0
	-speed [min <sup>-1</sup> ]	1320	1320	1320	1320
	-power consumption [kW]	3,7	3,7	3,7	3,7
	-max. airflow [m³/h]	6020	6020	6020	6020
	-motor protection class	IP 54	IP 54	IP 54	IP 54
Terminal box protection class		IP 54	IP 54	IP 54	IP 54
Filter class		EU5	EU5	EU5	EU5
Total sound pressure level at 1 m [dBA]		58	58	58	58
Wiring diagram		No. 13	No. 13	No. 13	No. 13



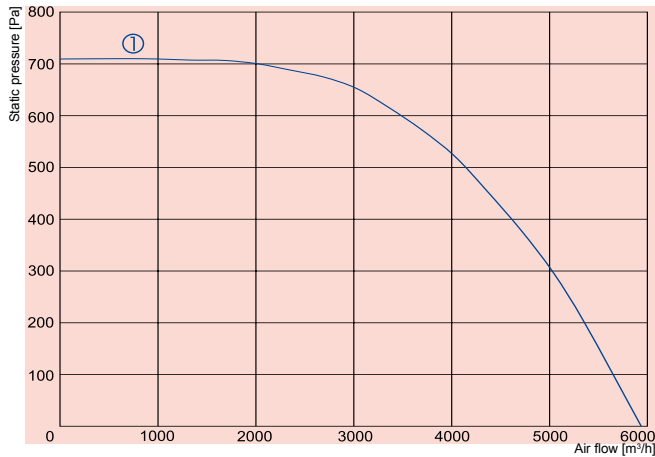

① VEKA W-4000/54,0-L3

Air handling units

**W-4000/54,0-L3**

Water heater	-power	[kW]	54
	-water temp. $T_{in}/T_{out}$	[°C]	+80/+60
	-water flow rate	[l/s]	0,71
	-water pressure drop	[kPa]	8,2
	-kvs value	[kPa]	9
Fan	-phase/voltage	[50Hz/VAC]	~3, 400
	-current	[A]	6,0
	-speed	[min <sup>-1</sup> ]	1320
	-power consumption	[kW]	3,7
	-max. airflow	[m <sup>3</sup> /h]	5940
	-motor protection class		IP-54
	Terminal box protection class		IP-54
	Filter class		EU5
	Total sound pressure level at 1 m	[dBA]	58
	Wiring diagram		No. 15

**VEKA 400E; 700E; 850E; 1000E versions with electrical heater (view from inspection side)**

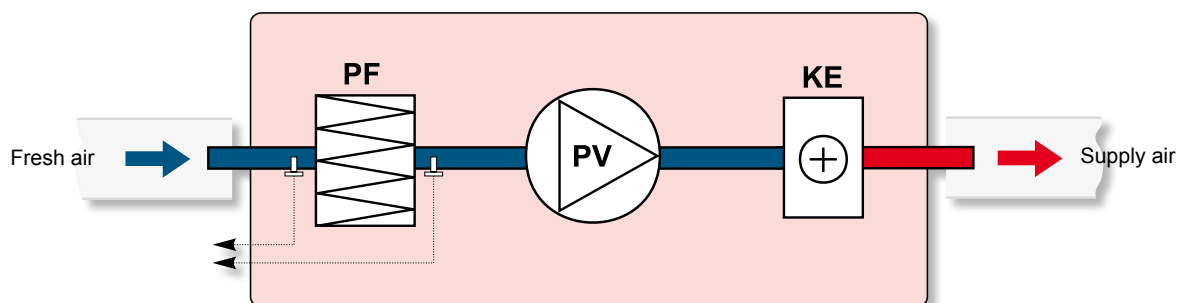

- PV** - supply air fan
- PF** - filter for supply air (class EU5)
- KE** - electrical heater

**VEKA 2000E; 3000E; 4000E versions with electrical heater (view from inspection side)**

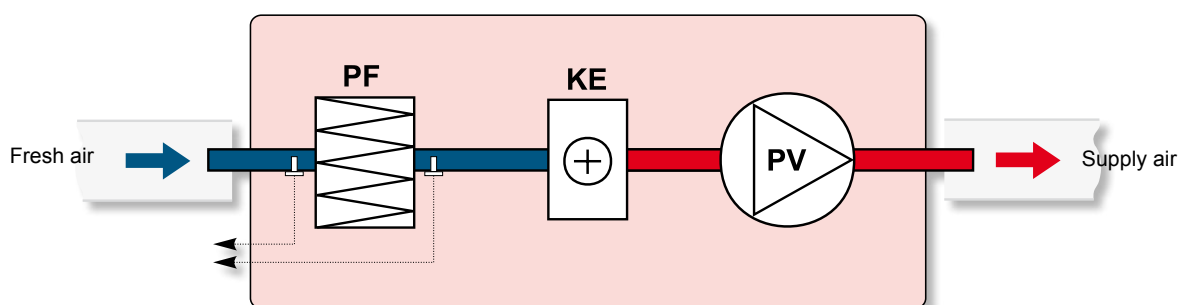

- PV** - supply air fan
- PF** - filter for supply air (class EU5)
- KE** - electrical heater

**VEKA 1000W versions with water heater (view from inspection side)**

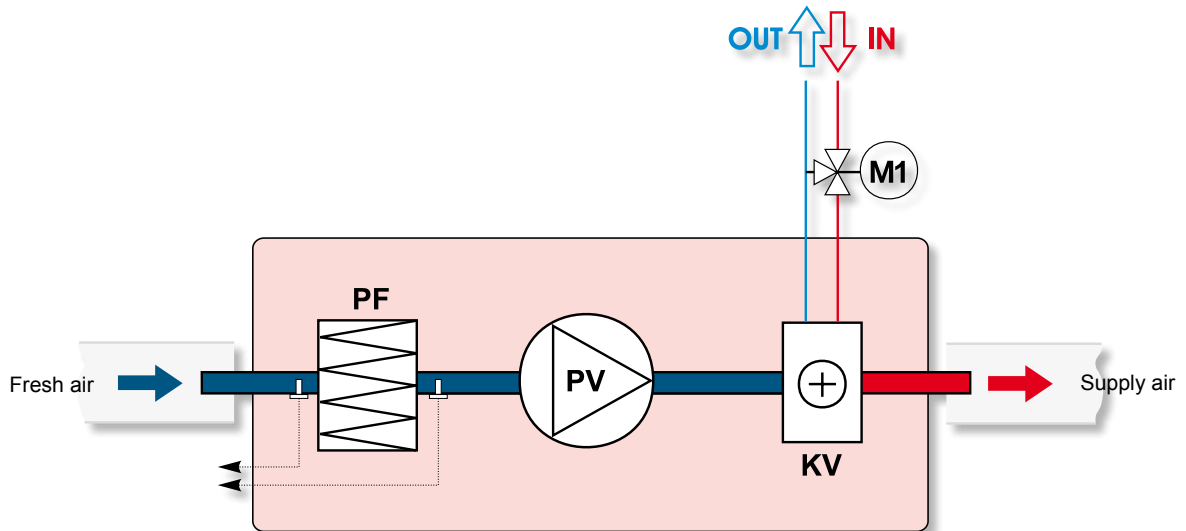

- PV** - supply air fan
- PF** - filter for supply air (class EU5)
- KV** - water heater
- M1** - optionally supplied mixing valve and motor

**VEKA 2000W; 3000W; 4000W versions with water heater (view from inspection side)**

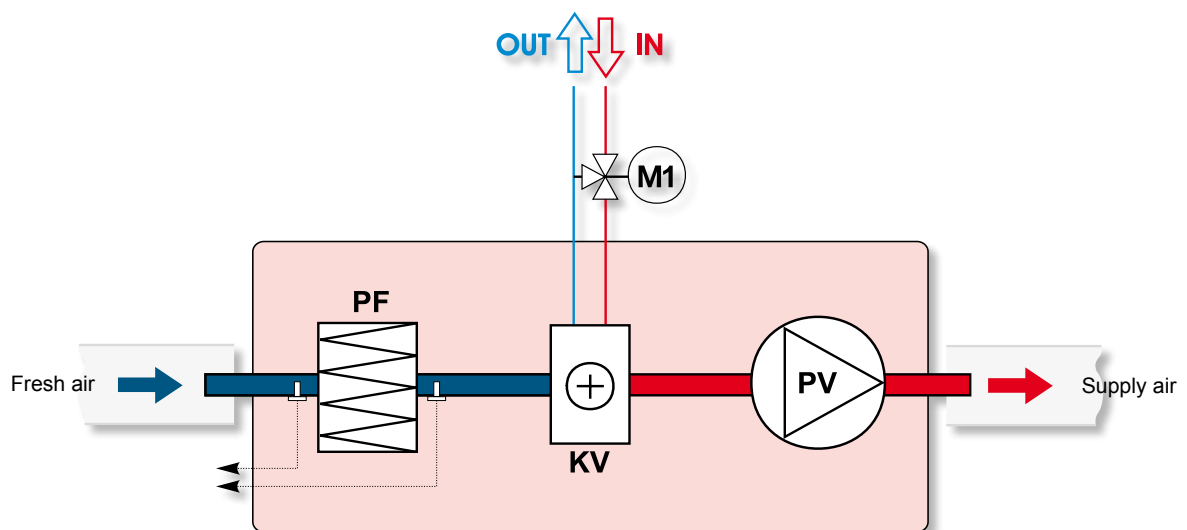

- PV** - supply air fan
- PF** - filter for supply air (class EU5)
- KV** - water heater
- M1** - optionally supplied mixing valve and motor

**Wiring diagram No. 1**

C -Centrifugal fan  
D -Electrical heater

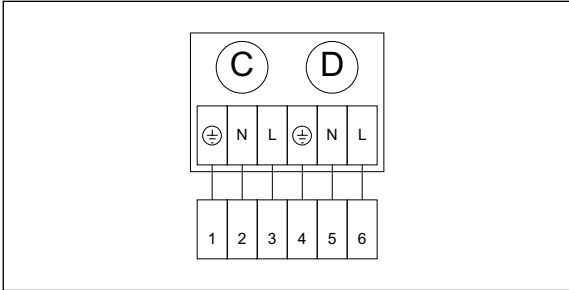

**Wiring diagram No. 2**

C -Centrifugal fan  
D -Electrical heater

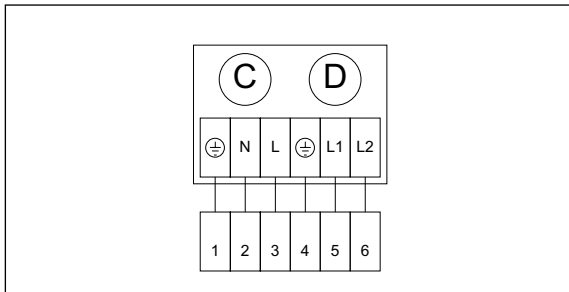

**Wiring diagram No. 3**

C -Centrifugal fan  
D -Electrical heater

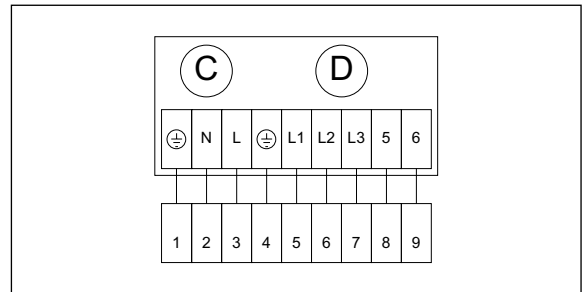

**Wiring diagram No. 4**

C -Centrifugal fan  
D -Electrical heater

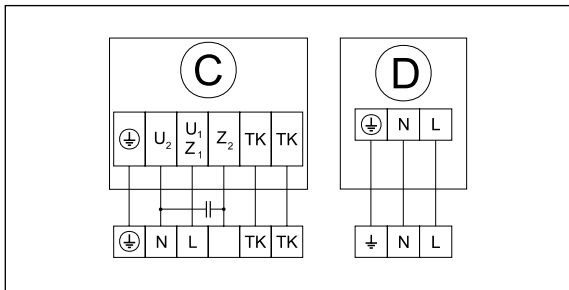

**Wiring diagram No. 5**

C -Centrifugal fan  
D -Electrical heater

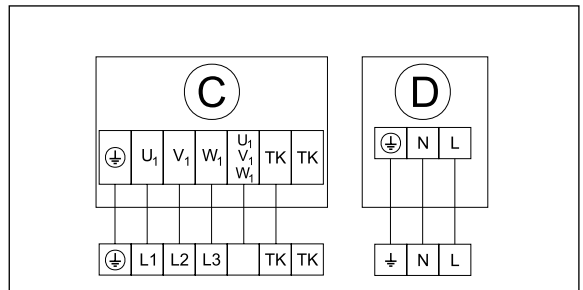

**Wiring diagram No. 6**

C -Centrifugal fan  
D -Electrical heater

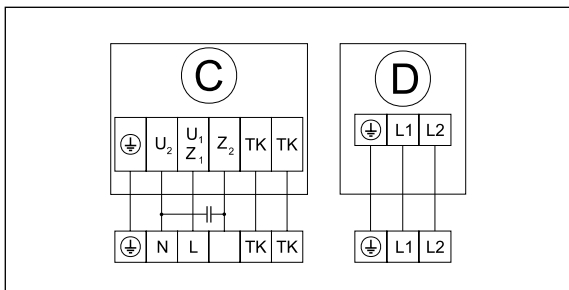

**Wiring diagram No. 7**

C -Centrifugal fan  
D -Electrical heater

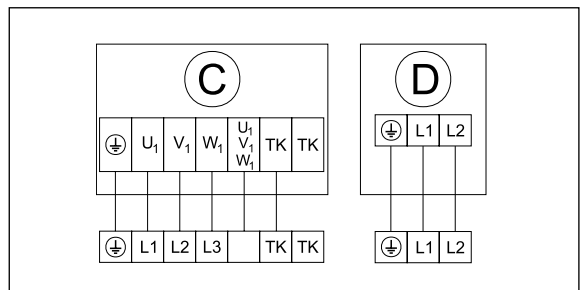

**Wiring diagram No. 8**

- C -Centrifugal fan
- D -Electrical heater

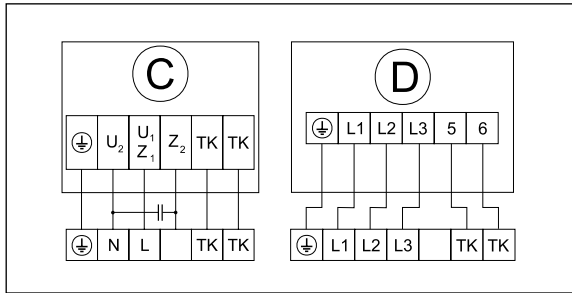

**Wiring diagram No. 9**

- C -Centrifugal fan
- D -Electrical heater

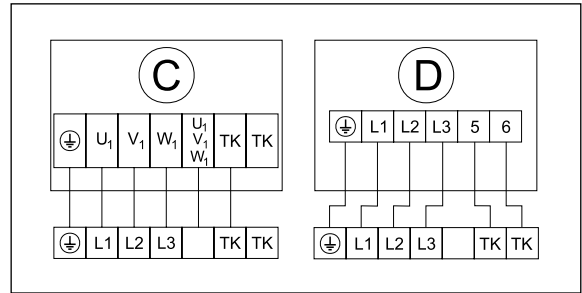

**Wiring diagram No. 10**

- A -Overheat protection with manual reset 100°C
- B -Overheat protection with automatical reset 50°C
- C -Centrifugal fan
- D -Electrical heater

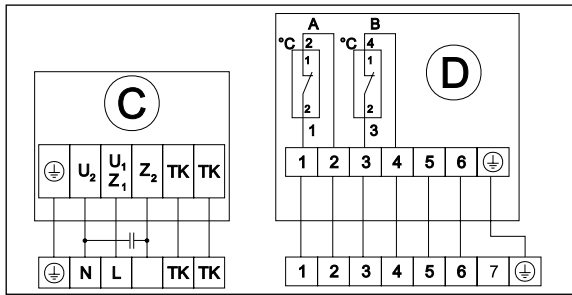

**Wiring diagram No. 11**

- A -Overheat protection with manual reset 100°C
- B -Overheat protection with automatical reset 50°C
- C -Centrifugal fan
- D -Electrical heater

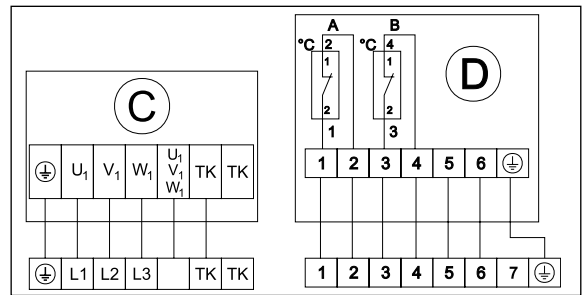

**Wiring diagram No. 12**

- A -Overheat protection with manual reset 100°C
- B -Overheat protection with automatical reset 50°C
- C -Centrifugal fan
- D -Electrical heater

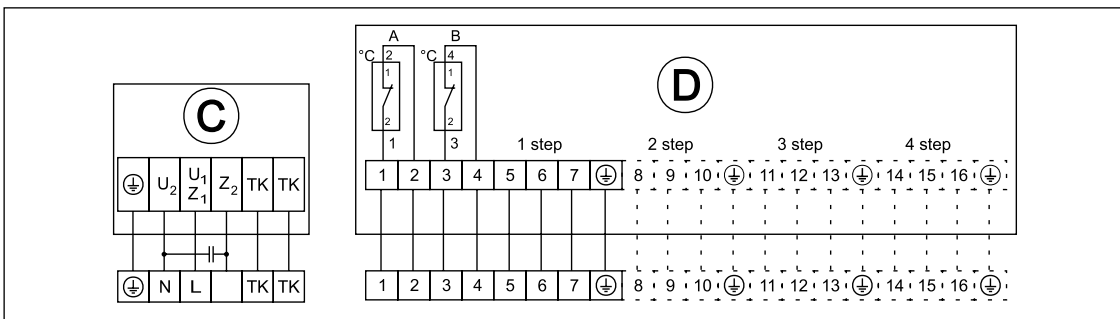

**Wiring diagram No. 13**

- A -Overheat protection with manual reset 100°C
- B -Overheat protection with automatical reset 50°C
- C -Centrifugal fan
- D -Electrical heater

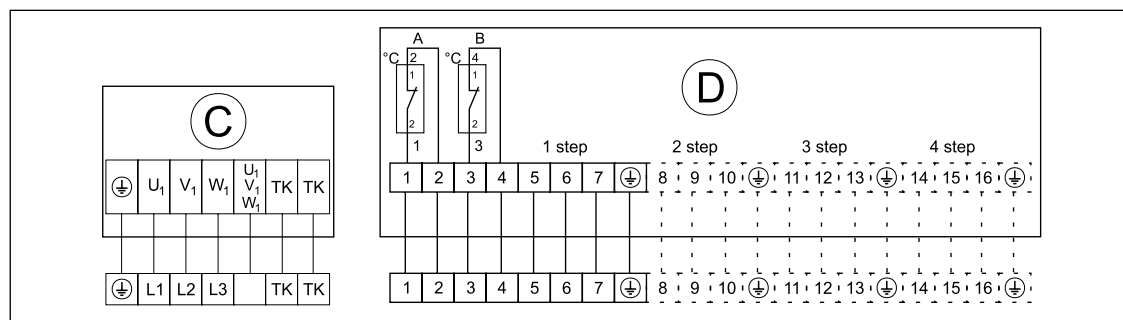

**Wiring diagram No. 14**

- C -Centrifugal fan

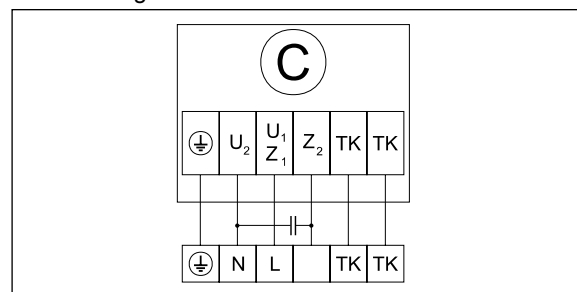

**Wiring diagram No. 15**

- C -Centrifugal fan

